

Probler P2

Dispense Gun

**For use with non-flammable foam and polyurea.
Not for use in explosive atmospheres.**

*90-110 psi (0.62-0.76 MPa, 6.2-7.6 bar) Air Inlet Pressure Range
3500 psi (24.1 MPa, 241 bar) Maximum Static Fluid Pressure*



Important Safety Instructions

Read all warnings and instructions in this manual. Save these instructions.

Models:

GCP2RA
GCP2R0
GCP2R1
GCP2R2
GCP2R3
GCP2R4
GCP2R5

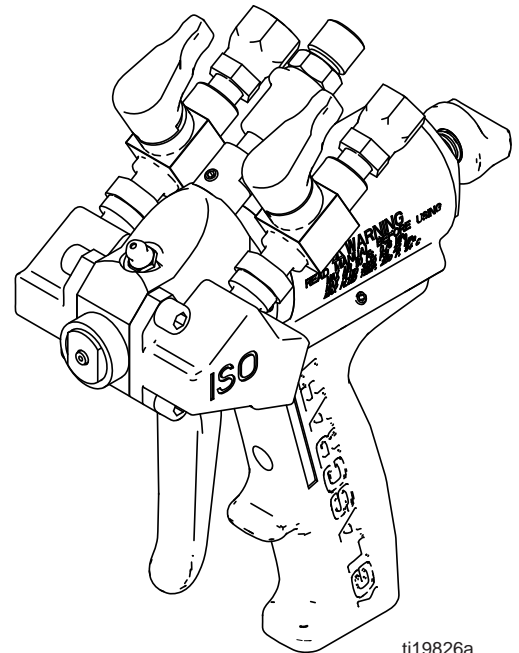

ti19826a



Table Of Contents

Section 1 Installation

Warnings	3
Introduction	7
Standard Equipment	8
Translations	8
Equipment Assembly	9

Section 2 Operation

Start-up Instructions	11
-----------------------------	----

Section 3 General Information











Assembly Drawings	13
Maintenance	15
Options	20

Section 4 Warranty and Reference Information

Graco Warranty	26
Technical Assistance	27
For Your Reference	28

Warnings

The following warnings are for the setup, use, grounding, maintenance, and repair of this equipment. The exclamation point symbol alerts you to a general warning and the hazard symbol refers to procedure-specific risk. Refer back to these warnings. Additional, product-specific warnings may be found throughout the body of this manual where applicable.

 WARNING	
 	<p>TOXIC FLUID OR FUMES HAZARD</p> <p>Toxic fluids or fumes can cause serious injury or death if splashed in the eyes or on skin, inhaled, or swallowed.</p> <ul style="list-style-type: none"> • Read MSDS's to know the specific hazards of the fluids you are using. • Store hazardous fluid in approved containers, and dispose of it according to applicable guidelines. • Always wear impervious gloves when spraying or cleaning equipment.
	<p>PERSONAL PROTECTIVE EQUIPMENT</p> <p>You must wear appropriate protective equipment when operating, servicing, or when in the operating area of the equipment to help protect you from serious injury, including eye injury, inhalation of toxic fumes, burns, and hearing loss. This equipment includes but is not limited to:</p> <ul style="list-style-type: none"> • Protective eyewear • Clothing and respirator as recommended by the fluid and solvent manufacturer • Gloves • Hearing protection
  	<p>SKIN INJECTION HAZARD</p> <p>High-pressure fluid from gun, hose leaks, or ruptured components will pierce skin. This may look like just a cut, but it is a serious injury that can result in amputation. Get immediate surgical treatment.</p> <ul style="list-style-type: none"> • Do not point gun at anyone or at any part of the body. • Do not put your hand over the spray tip. • Do not stop or deflect leaks with your hand, body, glove, or rag. • Close material shutoff valves and shutoff or disconnect air supply when not spraying. • Follow Pressure Relief Procedure in this manual, when you stop spraying and before cleaning, checking, or servicing equipment.
	<p>BURN HAZARD</p> <p>Equipment surfaces and fluid that's heated can become very hot during operation. To avoid severe burns, do not touch hot fluid or equipment. Wait until equipment/fluid has cooled completely.</p>
  	<p>FIRE AND EXPLOSION HAZARD</p> <p>Flammable fumes, such as solvent and paint fumes, in work area can ignite or explode. To help prevent fire and explosion:</p> <ul style="list-style-type: none"> • Use equipment only in well ventilated area. • Eliminate all ignition sources; such as pilot lights, cigarettes, portable electric lamps, and plastic drop cloths (potential static arc). • Keep work area free of debris, including solvent, rags and gasoline. • Do not plug or unplug power cords, or turn power or light switches on or off when flammable fumes are present. • Ground all equipment in the work area. • Use only grounded hoses. • Hold gun firmly to side of grounded pail when triggering into pail. • If there is static sparking or you feel a shock, stop operation immediately. Do not use equipment until you identify and correct the problem. • Keep a working fire extinguisher in the work area.

Warnings

WARNING



EQUIPMENT MISUSE HAZARD

Misuse can cause death or serious injury.

- Do not operate the unit when fatigued or under the influence of drugs or alcohol.
- Do not exceed the maximum working pressure or temperature rating of the lowest rated system component. See Technical Data in all equipment manuals.
- Use fluids and solvents that are compatible with equipment wetted parts. See Technical Data in all equipment manuals. Read fluid and solvent manufacturer's warnings. For complete information about your material, request MSDS forms from distributor or retailer.
- Check equipment daily. Repair or replace worn or damaged parts immediately with genuine manufacturer's replacement parts only.
- Do not alter or modify equipment.
- Use equipment only for its intended purpose. Call your distributor for information.
- Route hoses and cables away from traffic areas, sharp edges, moving parts, and hot surfaces.
- Do not kink or over bend hoses or use hoses to pull equipment.
- Keep children and animals away from work area.
- Comply with all applicable safety regulations.



PRESSURIZED ALUMINUM PARTS HAZARD

Do not use 1,1,1-trichloroethane, methylene chloride, other halogenated hydrocarbon solvents or fluids containing such solvents in pressurized aluminum equipment. Such use can cause serious chemical reaction and equipment rupture, and result in death, serious injury, and property damage.

Warnings



Isocyanate Hazard

					
<p>Spraying materials containing isocyanates creates potentially harmful mists, vapors, and atomized particulates.</p> <p>Read material manufacturer's warnings and material MSDS to know specific hazards and precautions related to isocyanates.</p> <p>Prevent inhalation of isocyanate mists, vapors, and atomized particulates by providing sufficient ventilation in the work area. If sufficient ventilation is not available, a supplied-air respirator is required for everyone in the work area.</p> <p>To prevent contact with isocyanates, appropriate personal protective equipment, including chemically impermeable gloves, boots, aprons, and goggles, is also required for everyone in the work area.</p>					

To prevent exposing ISO to moisture:

- Always use a sealed container with a desiccant dryer in the vent, or a nitrogen atmosphere. **Never** store ISO in an open container.
- Keep the ISO lube pump reservoir filled with Graco Throat Seal Liquid (TSL), Part 206995. The lubricant creates a barrier between the ISO and the atmosphere.
- Use moisture-proof hoses specifically designed for ISO, such as those supplied with your system.
- Never use reclaimed solvents, which may contain moisture. Always keep solvent containers closed when not in use.
- Never use solvent on one side if it has been contaminated from the other side.
- Always park pumps when you shutdown.
- Always lubricate threaded parts with Part 217374 ISO pump oil or grease when reassembling.

Material Self-Ignition

					
<p>Some materials may become self-igniting if applied too thickly. Read material manufacturer's warnings and material MSDS.</p>					

Moisture Sensitivity of Isocyanates

Isocyanates (ISO) are catalysts used in two component foam and polyurea coatings. ISO will react with moisture (such as humidity) to form small, hard, abrasive crystals, which become suspended in the fluid. Eventually a film will form on the surface and the ISO will begin to gel, increasing in viscosity. If used, this partially cured ISO will reduce performance and the life of all wetted parts.



The amount of film formation and rate of crystallization varies depending on the blend of ISO, the humidity, and the temperature.

Warnings

Keep Components A and B Separate

CAUTION

To prevent cross-contamination of the equipment's wetted parts, never interchange component A (isocyanate) and component B (resin) parts. The gun is shipped with the A side on the left. The fluid manifold, fluid housing, side seal assembly, check valve cartridge, and mix chamber are marked on the A side.

Foam Resins with 245 fa Blowing Agents

New foam blowing agents will froth at temperatures above 90°F (33 °C) when not under pressure, especially if agitated. To reduce frothing, minimize preheating in a circulation system.

Changing Materials

- When changing materials, flush the equipment multiple times to ensure it is thoroughly clean.
- Always clean the fluid inlet strainers after flushing.
- Check with your material manufacturer for chemical compatibility.
- Most materials use ISO on the A side, but some use ISO on the B side.
- Epoxies often have amines on the B (hardener) side. Polyureas often have amines on the B (resin) side.

Section 1 - Installation: Introduction

Introduction

Before operating, maintaining or servicing any **GlasCraft** system, read and understand all of the technical and safety literature provided with **GlasCraft** products. If you do not have the proper or related manuals and safety literature for your **GlasCraft** system, contact your **GlasCraft** distributor.

In this **GlasCraft** technical and safety publication, the following advisories will be provided where appropriate:



Information about the procedure in progress.



Indicates a hazardous situation that can result in death or serious injury.

The information in this document is intended only to indicate the components and their normal working relationship typical use. Each assembly should be directed by a **GlasCraft** distributor or made from the **GlasCraft** Assembly instructions provided.

This manual provides information for the assembly, operation, maintenance and service of this **GlasCraft** product as used in a typical configuration. While it lists standard specifications and procedures, some deviations may be found.

In order to provide our users with the most up-to-date technology possible, we are constantly seeking to improve products. If a technological change occurs after a product is on the market, we will implement that technology in future production and, if practical, make it available to current users as a retrofit, update or supplement. If you find a discrepancy between your unit and the available documentation, contact your **GlasCraft** distributor to resolve the difference.

Careful study and continued use of this manual will provide a better understanding of the equipment and process, resulting in more efficient operation, longer trouble-free service and faster, easier troubleshooting.

Section 1 - Installation: Standard Equipment

Standard Equipment	
Part Number	Description
GCP2RX	Probler P2 Dispense Gun
313213	User Manual

Translations	
Manual No.	Language
3A0472	Spanish
3A0473	French

Section 1 - Installation: Equipment Assembly

How The Gun Works

The trigger actuates a small valve in the gun handle that controls the flow of air into the piston assembly. When the trigger is pulled, air flows through the valve to the front of the piston. Air pressure forces the piston towards the rear of the gun, simultaneously closing off the purge air and moving the mixing chamber to a position where the mixing chamber orifices are aligned with the orifices in both the side block seal and check valve assemblies.

 The proper alignment of the orifices is determined by the setting of the adjustment nut, located on the piston lock assembly. This adjustment nut determines the length of travel of the air piston and has been preset at the factory and should not require adjustment. (SEE MAINTENANCE SECTION)

The two fluids (isocyanate and polyol) then flow through the material shut-off valves, seal, and check valve assemblies and into the mixing chamber. The two fluids impinge against one another and exit the mixing chamber in a swirling, conical spray pattern.

When the trigger is released, the mixing chamber returns to its original position and purge air flows into the mixing chamber housing. The front tip o-ring, keeps air purge inside the gun head, forcing all of the air through the orifices in the mixing chamber, for a complete, total and constant purge.

This purge air continues to flow through the mixing chamber until the air switch is pulled up to shut-off all air to the gun; or until the trigger is pulled again.

Piston Lock

Engage piston lock whenever you stop spraying, to avoid accidental triggering.

Always use piston lock in conjunction with fluid ball valves to avoid accidental triggering.



Read warnings, page 3.

To engage Piston lock: push knob in and turn clockwise. If engaged, gun will not actuate.

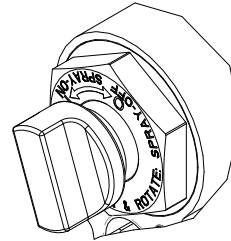

r_257826_313266_1_2b

To disengage piston lock: push knob in and turn counterclockwise until it pops out. There will be a gap between knob and gun body.

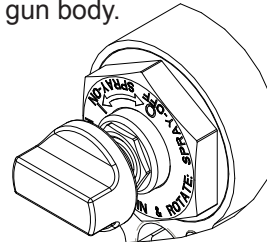

r_257826_313266_1_1b

See page 19 for piston lock adjustment or installation.

Loss of Air Pressure

In event of loss of air pressure, gun will continue to spray. To shut off gun, do one of the following:

- Push in piston lock, see **Engage piston lock**.
- Close ball valves A and B.

Section 1 - Installation: Equipment Assembly

GlasCraft Equipment

Air Hose is ¼ in. NPS

JIC and SAE Fittings **DO NOT** require the use of PTFE tape.

Once the fittings are attached and tight, refer to system manuals for start-up instructions.

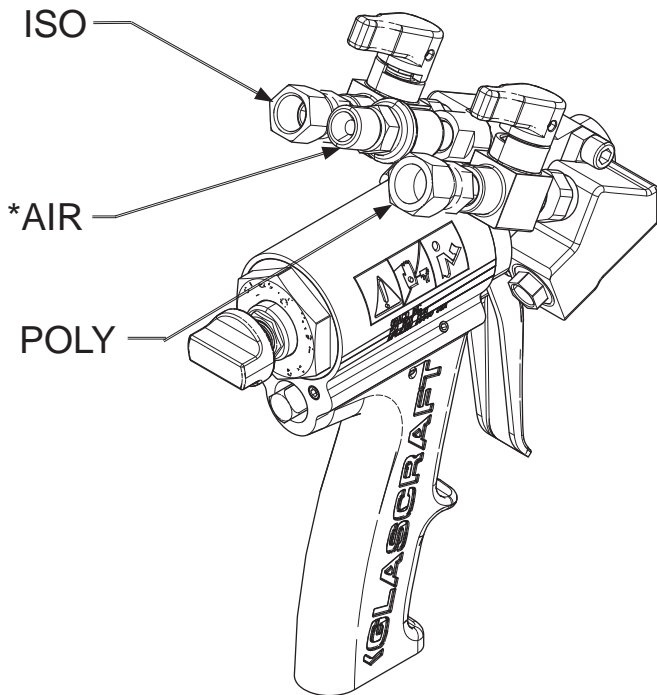

*Fitting GC2394 is an unattached part that may need to be connected to the air hose first, depending on air hose fitting, then connected to the gun.

Installing P2 on Other Equipment

⚠ WARNING

Do not place any part of the body in the path of the material spray. Do not point the gun at or near other personnel. Do not look into the mixing chamber orifice at any time. Because of the hazardous materials used in this equipment, it is recommended that the operator use an air mask, goggles, protective clothing, and other safety equipment as prescribed by current regulations, recommendations of the chemical suppliers, and the laws in the area where the equipment is being used.

If original equipment does not require the use of an unheated whip hose or isolation hose, the P2 can be directly installed on to the material hose.

1. Remove the fittings from the original gun.
2. Remove swivel fittings from ball valves. Ball valves are 1/8 in. NPT female. Remove swivel fitting from air slide valve. The air slide valve is a ¼ in. NPSM.

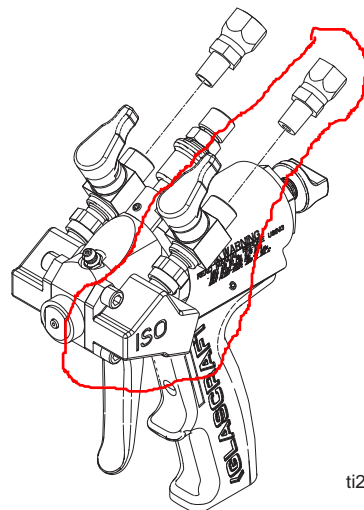

3. Install the original fittings into ball valves.



It is recommended to use a non-permanent thread lock on the 1/8 in. NPT threads to assist as a sealant and keep the fittings from twisting with gun movement.

4. Install the gun on the original hoses.

⚠ WARNING

Relieve ALL system fluid and air pressure according to manufacturer's instructions.

Section 2 - Operation: Start-Up Instructions

 Refer to specific system user manuals for complete system installation.

Pre operation Checklist

Check that all fittings are tight and air regulators are turned to “zero pressure”.

WARNING

Do not place any part of the body in the path of the material spray.

Do not point the gun at or near other personnel.

Do not look into the mixing chamber orifice at anytime.

Because of the hazardous materials used in this equipment, it is recommended that the operator use an air mask, goggles, protective clothing, and other safety equipment as prescribed by current regulations, recommendations of the chemical suppliers, and the laws in the area where the equipment is being used.

Operating Requirements

- 8-10 CFM at 90-110 psi (0.62-0.76 MPa, 6.2-7.6 bar)
- MAXIMUM Static Fluid Pressure - 3500 psi (24.1 MPa, 241 bar)

WARNING

The GlasCraft Probler P2 Gun is designed and manufactured to operate at a maximum static fluid pressure not to exceed 3500 psi (24.1 MPa, 241 bar). When attached to a GlasCraft proportioning system, this pressure will not be exceeded. However, if the GlasCraft Probler P2 Gun is installed on any other manufacturer's self-designed equipment, great care must be taken to ensure that the maximum static fluid pressure not be exceeded.

 If the gun is being used for short periods of spraying, GlasCraft recommends that the purge air be left ON.

WARNING

If purge air is to be turned OFF, BOTH MATERIAL SHUT-OFF VALVES, MUST BE TURNED TO THEIR “OFF” POSITION AND PISTON-LOCK ENGAGED BEFORE TURNING “OFF” THE PURGE AIR !

Failure to follow this procedure will possibly result in the gun head becoming encased with mixed product.

For proper purging following use, the air switch must be left OPEN for at least 15 SECONDS after the trigger has been released.

The flow of material into the mixing chamber is controlled by the ON or OFF position of the two material shut-off valves.

 Both material shut-off valves must be FULLY OPEN and piston lock DISENGAGED during dispensing and must be FULLY CLOSED and piston lock ENGAGED during service or extended shut-down periods.

WARNING

BOTH MATERIAL SHUT-OFF VALVES, MUST BE TURNED TO THEIR “OFF” POSITION AND ALL FLUID PRESSURE RELIEVED BEFORE REMOVING SIDE BLOCK SCREWS!!

Failure to follow this procedure will possibly result in the gun head becoming encased with mixed product.

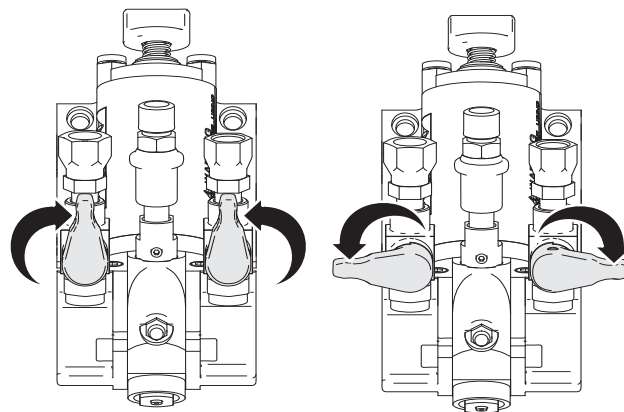

ti19823a

ON

OFF

Refer to system manuals for start-up and shut-down procedures.

Section 2 - Operation: Start-Up Instructions

Spray Technique

Always operate safely and follow all safety procedures outlined.

To achieve the optimum spray pattern for each application, the appropriate mixing chambers are available in seven spray sizes.

The standard mixing chamber supplied with your gun will be adequate for all but the smallest and largest applications.

Foam rise and cure times will vary according to the material and substrate temperature. Higher material or substrate temperature will increase rise and cure times; lower material or substrate temperatures will decrease rise and cure times. Consult your chemical manufacturer's data specification sheets for their recommended spray temperatures. Under most circumstances, both components will be used at identical temperatures.

Higher pressures and temperatures may be used to increase material break-up, improve mixing and speed rise times. With hose lengths over 50 ft., or when material viscosities are high, higher material pump pressures may be necessary.

The gun air switch assembly **MUST BE OPENED** (down position) prior to spraying to provide air for trigger operation and purge air when the trigger is released.

When spraying, the gun trigger may be depressed continuously, or triggered at the end of each stroke. A smooth, even layer is best achieved by moving the gun back and forth in a slow, even motion, overlapping the previous pass about 50 to 75 percent. **DO NOT SPRAY OVER RISING FOAM!** The ideal gun-to-surface distance is about 18 to 24 inches. Be sure to point the gun directly at the surface to be sprayed. Spraying at an angle to the surface will cause the foam to be rough and will generate overspray.

Section 3 - General Information: GCP2RX P2 Dispense Gun

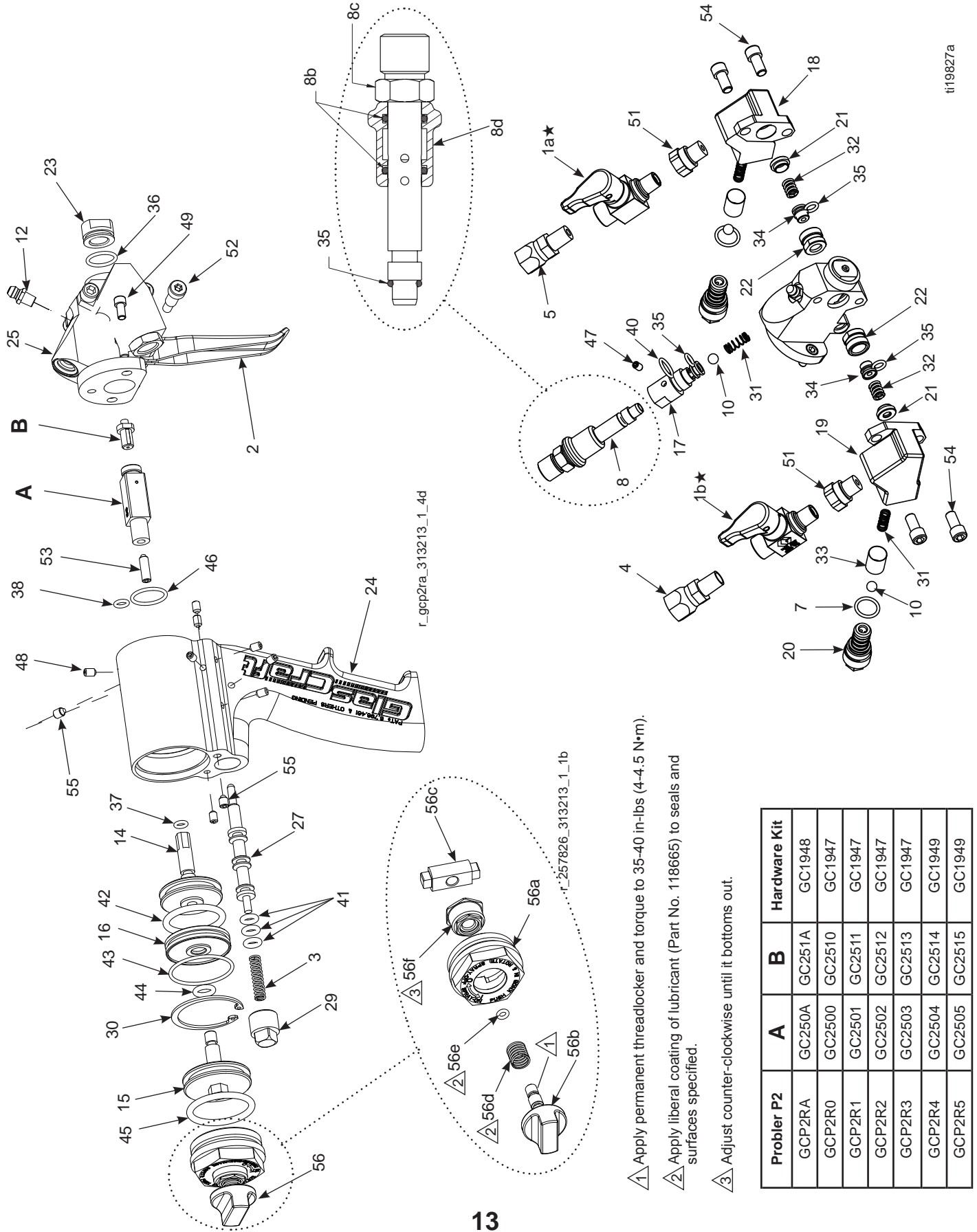

tr19827a

Section 3 - General Information: GCP2XX P2 Parts List

Ref. No.	Part No.	Description	Qty.
1a★	256459	ISO BALL VALVE	1
1b★	256460	POLY BALL VALVE	1
2	GC2340	PROBLER TRIGGER	1
3	GC2341	COMPRESSION SPRING	1
4	117634	SWIVEL HOSE FITTING	1
5	117635	SWIVEL HOSE FITTING	1
9*	15B772	1/4 NPSM (FBE) AIR HOSE (18 in.)	1
7	248130	O-RING (QTY. 6)	1
8	GC0128	AIR SWITCH ASSEMBLY	1
10	GC0259	1/4 DIA BALL	3
12	100846	LUBE FITTING	1
13*	GC2394	SWIVEL FITTING	1
14	GC1898	1-3/8" AIR PISTON	1
15	GC1899	1-1/2" AIR PISTON	1
16	GC1900	CYLINDER SPACER	1
17	GC1901	VALVE INSERT	1
18	16N599	ISO SIDE BLOCK	1
19	16N600	POLY SIDE BLOCK	1
20	16P010	CHECK VALVE FILTER	2
21	GC2494	SEAL	2
22	GC2495	SEAL HOUSING	2
23	GC1914	AIR CAP	1
24	GC2499	HANDLE	1
25	GC1916	PROBLER P2 HEAD	1
27	GC1918	TRIGGER PISTON	1
29	GC1920	TRIGGER PLUG	1
30	GC1921	RETAINING RING	1
31 X	GC1922	SPRING	3
32	GC1923	SPRING	2
33 † X	GC2496	FILTER SCREEN, 40 MESH	2
34	GC2498	SEAL	2
35	248128	O-RING (QTY. 6)	4
36	248131	O-RING (QTY. 6)	1
37	C20988	O-RING	1
38	GC2056	O-RING	1
39	110242	O-RING	1
40	GC2057	O-RING	1
41	GC2058	O-RING	3

Ref. No.	Part No.	Description	Qty.
8b	106555	O-RING	2
8c	GC0126	AIR SWITCH TUBE	1
8d	GC0127	AIR SWITCH SPOOL	1

Ref. No.	Part No.	Description	Qty.
42	108833	O-RING	1
43	107563	O-RING	1
44	GC2059	O-RING	1
*	118665	HIGH ADHESION, WATER RESITANT, LITHIUM GREASE (4 OZ.)	1
*	117773	LOW VISCOSITY GREASE (3 OZ.)	1
*	117792	GREASE GUN (3 OZ. CARTRIDGE)	1
45	C20207	O-RING	1
46	GC2060	O-RING	1
47	GC2079	SET SCREW	1
48	GC2081	SET SCREW	11
49*	GC2187	MACHINE SCREW	2
51	15U395	1/8 NPT ADAPTER	2
52	GC2237	SHOULDER SCREW	1
53	GC2243	SET SCREW	1
54	GC2248	MACHINE SCREW	4
55	GC2241	SET SCREW	2
56	258761	PISTON LOCK ASSEMBLY	1

Ref. No.	Part No.	Description	Qty.
56a		AIR CAP	1
56b ♦		STOP SHAFT	1
56c ♦		PISTON STOP	1
56d ♦		COMPRESSION SPRING	1
56e ♦		O-RING	1
56f		ADJUSTMENT NUT	1

* Not shown.

† 100 Mesh filter GC2497 also available.

♦ Included with kit 258762.

X Available in bulk kits. See page 21.

★ Replacement handles are available in kit 24W375.

Section 3 - General Information: Maintenance

WARNING

Before attempting to perform any maintenance on this gun, relieve All Fluid and Air Pressures!

- To relieve fluid and air pressures:
- Turn OFF all air supplies at system except gun trigger air.
- Trigger the gun until all fluid pressures have been relieved.
- Turn OFF the gun trigger air at the system.
- Turn proportioner off.
- Trigger the gun until all trigger air pressure has been relieved.

Perform Gun maintenance as follows:

1. Check for leaking seals (34):

- Engage piston lock.
- Turn OFF the gun incoming air by closing gun air switch.

Air Switch

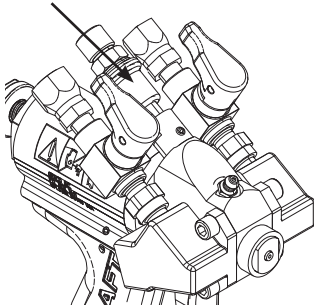

- Wait approximately 10 - 20 seconds, then turn ON the incoming air by opening gun air switch.
- Repeat two or three times.
- If any material has been purged from the gun, the seals (34) are leaking, or o-ring (35).
- Correct leaks by replacing the seals or o-rings and re-checking.

2. Check the material valves, p/n 256459 and 256460 for any leaks:

- Turn OFF both material valves.

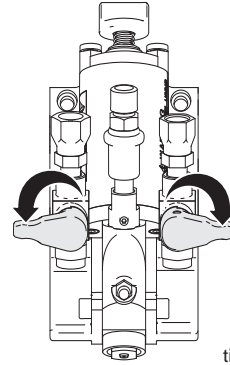

ti19825a

- Disengage piston lock.
- Trigger the gun several times.
- Wait approximately 10-20 seconds.
- Trigger the gun several times.
- If additional material is purged, the material valves are leaking.
- Correct the leaks by loosening the set screw and removing red or blue handle. Turn the valve packing nut clockwise in 1/8-turn increments until leak is corrected. Re-check.

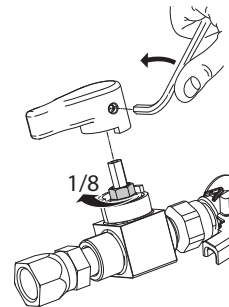

ti19008a

3. Check side blocks

- Turn OFF the air switch on the gun.

WARNING

Before removing the side blocks make certain that both material valves are in the OFF positions and trigger several times to depressurize fluid in gun!

If the material valves are on when the side blocks are removed the gun will quickly become encased in urethane!

WARNING

Point gun side blocks down, away from all personnel. Existing fluid pressures could cause material to exit the side blocks with considerable force.

Section 3 - General Information: Maintenance

- Take the side blocks off by removing screws.

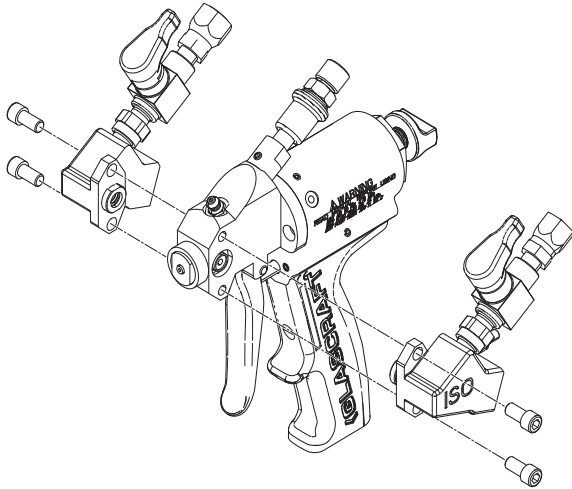

ti21611a

- Examine the sides of the mixing chamber for scratches and/or material build-up. Carefully, without scratching the seal surfaces (sides), remove any accumulated material. Solvent can be used to wash accumulated material off of chamber, side blocks, etc. Keep the gun chamber tilted toward the ground so that solvent does not run back into gun. Certain solvents will attack o-rings on chamber shaft causing swelling and deterioration of o-rings.

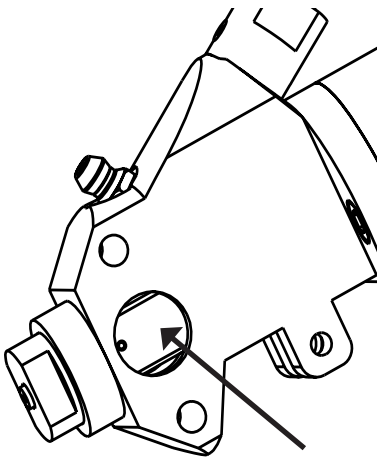

- Place generous amounts of high quality, white lithium grease (Part No. 117773) in each side of the gun front housing and on the side block seals.

- Use correct size drill bit to clean out the mixing chamber exit passage. Use correct size drill bit to clean the inlet side holes of the mixing chamber taking care not to scratch the mixing chamber's polished surfaces (refer to the drill chart).

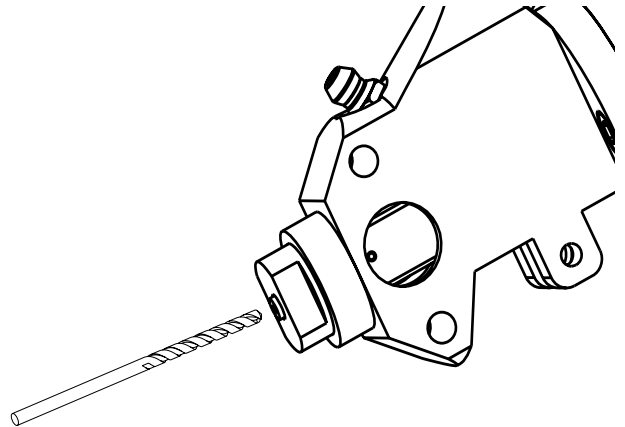

- Re-assemble the side blocks and tighten the screws. Grease should appear at the tip of the mixing chamber.

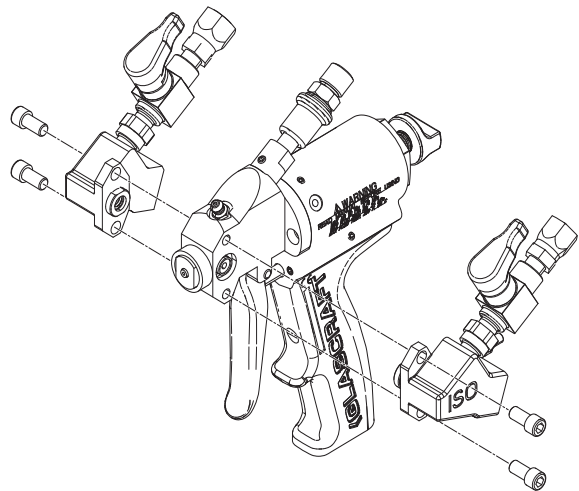

ti21611a

 **DO NOT** open the air switch on the gun because this will purge grease from the gun. The grease should be allowed to remain in the gun overnight.

Section 3 - General Information: Maintenance

Daily Shut-Down

For experienced users

Once you have used the gun with a product and system, and you have become comfortable with techniques on how all the variables are affecting your operations and maintenance requirements, Daily, Weekly, and Monthly maintenance requirements can be addressed specific to your operation.

1. Turn the ball valves off, activate and deactivate the gun 5 - 6 times to purge residual pressure.

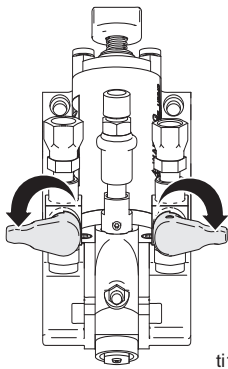

ti19825a

2. Engage piston lock.
3. Drill out the chamber insert snout with correct size drill bit for insert (see drill chart).
4. Pull slide valve halfway back to limit the air purge.

Air Switch

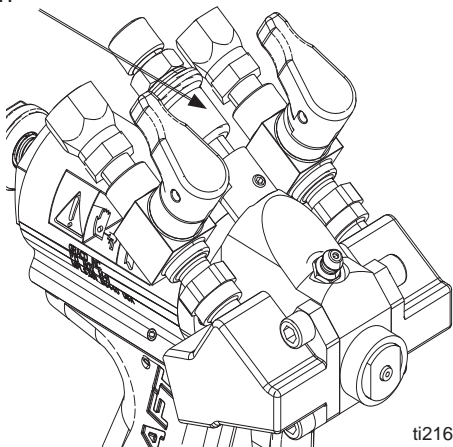

ti21611a

5. Use grease gun (Part No. 117792) to inject white lithium grease (Part No. 117773) into zerk fitting until a light mist of grease is purged through the snout. Shut off the air purge.

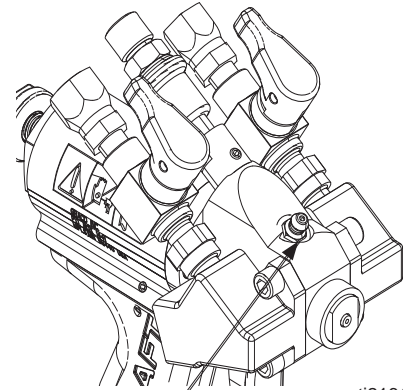

ti21611a

Zerk Fitting

6. Remove the air cap and set to side. If solvent soaking is required, remove the o-ring before soaking.
7. Remove the snout insert and soak in solvent until next usage.

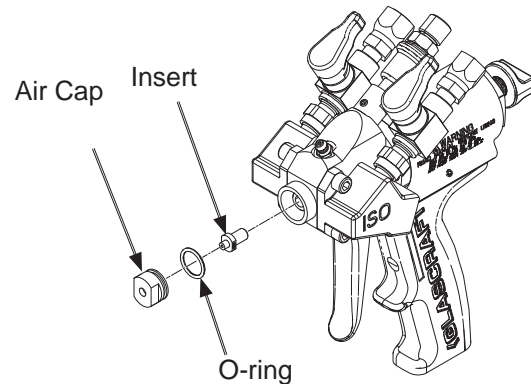

ti21613a

Daily Start-Up

8. Clean the snout insert. Be sure both, the face and bottom flat are clean. Drill the snout bore out with the correct size bit for snout (see drill chart).
9. Clean the inner bore of the chamber. Drill out the chamber snout inlet bore as required.
10. Install the snout insert.
11. Install the air cap on to the chamber. Tighten finger tight until the cap bottoms out. Snug down with a 1/2 in. wrench. This does not require high torque. Over tightening can result in chamber damage.

Section 3 - General Information: Maintenance

 Refer to specific system user manuals for complete system installation.

Parts Replacement Procedure

WARNING

Before attempting to perform any maintenance on this gun OR before removing the side blocks, make certain that both gun material valves are in the OFF positions and trigger several times to depressurize fluid in gun!

If the material valves are on when side blocks are removed, the gun will quickly become encased in urethane!

1. Read each procedure entirely before beginning and refer to the illustrations as needed.
2. Flush and clean all chambers and passages as they become accessible.
3. Clean all parts before assembly.
4. Replace all o-rings and seals with new parts from the appropriate kit.
5. Inspect all parts for wear or damage and replace as required with new *genuine GlasCraft replacement parts from your authorized GlasCraft distributor.*
6. Inspect all threads for wear or damage and replace as required.
7. Tighten all threaded parts securely, but not excessively, upon assembly.
8. Lightly lubricate all o-rings and threads with grease (Part No. 118665).
9. Check all springs for resilience. They should return quickly to their original (new) length.

Routine Care

WARNING

Before attempting to perform any maintenance on this gun OR before removing side blocks, make certain that both gun material valves are in the fully OFF positions and trigger several times to depressurize fluid in gun!

If the material valves are on when side blocks are removed, the gun will quickly become encased in urethane!

It is recommended that the following service be performed on a daily basis.

1. Clean the gun using a brush and an appropriate clean solvent.
2. Inspect the side block seals making certain they are clean and free of scratches, nicks or foreign material. Clean and replace as required.
3. Remove, clean or replace the filter screen.
4. Maintain a reasonable stock level of “wear” items such as seals and o-rings. (see Service & Repair Parts Kits listed in Parts & Illustrations section.)
5. Grease gun daily to prevent 2 component curing and keep fluid passages clean. Purge air carries grease mist through air chamber and impingement ports then out the mix chamber nozzle, coating all surfaces. Use Part No. 117773 grease.

Section 3 - General Information: Maintenance

Piston Lock Adjustment and Installation Procedure

The P2 gun piston throw is factory set and as a rule, should not require adjustment. The piston throw refers to how far back the air piston will travel when the gun is triggered. Proper throw adjustment will align the mixing chamber side ports with the side block seal thru port.

Determine if the piston throw is correct:

1. Follow the **pressure relief procedure** on page 15 and disconnect material hoses from the gun.
2. Turn the material ball valves to the OFF position.

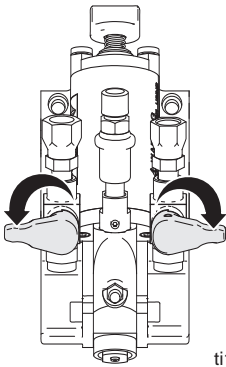

ti19825a

3. Verify that the piston lock cap has been tightened and fully threaded into the gun.
4. Remove the side blocks.

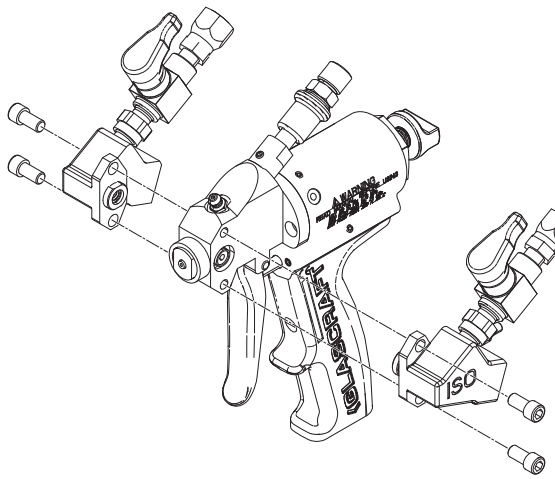

ti21612a

5. Remove one of the side block seal housings, from side block. Leave the seal (34) in housing and rinse with suitable solvent.

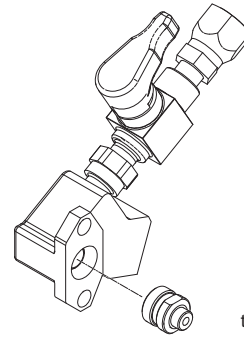

ti21614a

6. Place the side seal housing in the gun head so the face of the seal sets against the mix chamber.

WARNING

If the material valves are on when side blocks are removed, the gun will quickly become encased in urethane!

7. Turn the gun trigger air supply on, then trigger the gun.



The purge air will not shut off with the side block removed.

8. If the impingement port is not fully visible through the side seal housing turn the trigger-air off and trigger the gun to relieve pressure. Use a 9/16 in. open-end wrench to adjust the adjustment nut in the appropriate direction. Repeat steps 7 and 8 until it is adjusted properly.



Non-permanent thread locker can be applied to the adjustment nut if necessary.

10. Reassemble the gun.

Before each use: Verify that the piston lock assembly is installed and working properly.

- Engage piston lock.
- Pressurize the system to working pressure.
- Open material ball valves.
- Point the gun in a safe direction and trigger gun. No material should flow from gun tip.
- **DO NOT USE IF IT IS NOT WORKING PROPERLY.**

Section 3 - General Information: Options

Optional Equipment	
Part	Description
GC1938	Flat Spray Kit
GC1952	Jet Stream Nozzle (.059 ID)
GC1953	Jet Stream Nozzle (.070 ID)
GC1954	Pour Adapter
GC1892	* P2 Elite Conversion Kit

* Maximum working pressure 3200 psi (22 MPa, 220 bar)

GC1892		
Part	Description	Qty.
GC0024	PIPE PLUG	3
GC0275	FITTING	1
GC0490	ELBOW FITTING	1
GC0502	FITTING	1
GC0712	ELBOW FITTING	2
GC1842	BALL VALVE	1
GC1880	P2-ELITE HEAD	1
GC1881	POLY SIDE BLOCK	1
GC1882	ISO SIDE BLOCK	1
GC1883	PISTON SPACER	1
GC1884	MOUNTING PLATE	1
GC1885	SWIVEL ADAPTER	1
GC1886	WHIP HOSE	1
GC1887	WHIP HOSE	1
GC2212	FITTING	3
GC2244	SET SCREW	1
GC2334	FITTING	3
GC2337	BALL VALVE	2
313266	USER MANUAL	1

Section 3 - General Information: Options

Service & Repair Kits

GC1946, Side Seal Kit		
Part	Description	Qty.
GC2498	SST Side Seal	2
111450	O-Ring	2

GC1947, Hardware Kit 00-03		
Part	Description	Qty.
249112	Drill Bit	1
GC0069	Drill Bit	1
246629	Drill Bit	1
246630	Drill Bit	1
GC0083	Drill Bit	1
GC2394	Fitting	1
GC2212	Fitting	1
GC2334	Fitting	1
GC0086	3/16" Ball Driver	1
GC0087	5/32" Ball Driver	1
117661	Pin Vise	1
GC2496	Screen Filter	2
246628	Drill Bit	1
246627	Drill Bit	1
246625	Drill Bit	1
117517	O-Ring	1
111450	O-Ring	2

GC1948, Hardware Kit -AA		
Part	Description	Qty.
248891	Drill Bit	1
276984	Drill Bit	1
GC0086	Ball Driver	1
GC0087	Ball Driver	1
117661	Vise Pin	1
GC2496	Filter Screen	2
111450	O-Ring	2
117517	O-Ring	1

GC1949, Hardware Kit 04-05		
Part	Description	Qty.
GC0086	3/16" Ball Driver	1
GC0087	5/32" Ball Driver	1
117661	Pin Vise	1
GC2496	Screen Filter	2
246624	Drill Bit	1
246623	Drill Bit	1
117517	O-Ring	1
111450	O-Ring	2
GC2394	Adapter Fitting	1
GC2212	Connector Fitting	1
GC2334	Connector Fitting	1

258762, Piston Lock Repair Kit		
Part	Description	Qty.
	Stop Shaft	1
	Piston Stop	1
	Compression Spring	1
	O-Ring	1

Gun Cover

244914 Covers

Keeps gun clean while spraying. Pack of 10.

Lubricant for Gun Rebuild

248279, 4 oz (113 gram) [10]

High adhesion, water resistant, lithium-based lubricant. MSDS sheet available at www.graco.com.

Grease Cartridge for Gun

Shutdown

248280 Cartridge, 3 oz [10]

Specially formulated low viscosity grease flows easily through gun passages, to prevent 2 component curing and keep fluid passages clean.

Bulk Kits

24R894, 40 Mesh Filter Screens Kit			
Ref	Part	Description	Qty.
33	GC2496	Filter Screen, 40 mesh	10

24R895, 100 Mesh Filter Screens Kit			
Ref	Part	Description	Qty.
(33)	GC2497	Filter Screen, 100 mesh	10

24R896, Springs Kit			
Ref	Part	Description	Qty.
31	GC1922	Spring	12

Section 3 - General Information: Options

Service & Repair Kits

Ref.	GC1937, Standard Repair Kit		
	Part	Description	Qty.
6	113137	O-Ring	2
7	248130	O-Ring (Qty. 6)	2
8b	106555	O-Ring	2
35	248128	O-Ring (Qty. 6)	4
36	248131	O-Ring (Qty. 6)	1
37	C20988	O-Ring	1
38	GC2056	O-Ring	1
40	GC2057	O-Ring	1
41	GC2058	O-Ring	3
42	108833	O-Ring	1
43	107563	O-Ring	1
44	GC2059	O-Ring	1
45	C20207	O-Ring	1
46	GC2060	O-Ring	1

Ref.	GC1950, Premium Repair Kit		
	Part	Description	Qty.
6	113137	O-Ring	2
7	248130	O-Ring (Qty. 6)	2
8b	111316	O-Ring	2
35	248128	O-Ring (Qty. 6)	4
36	248131	O-Ring (Qty. 6)	1
37	GC1931	O-Ring	1
38	111516	O-Ring	1
39	111450	O-Ring	2
40	118594	O-Ring	1
41	GC1932	O-Ring	3
42	GC1933	O-Ring	1
43	GC1934	O-Ring	1
44	GC1935	O-Ring	1
45	GC1936	O-Ring	1
46	117610	O-Ring	1

Complete O-ring Kit Placement Guide

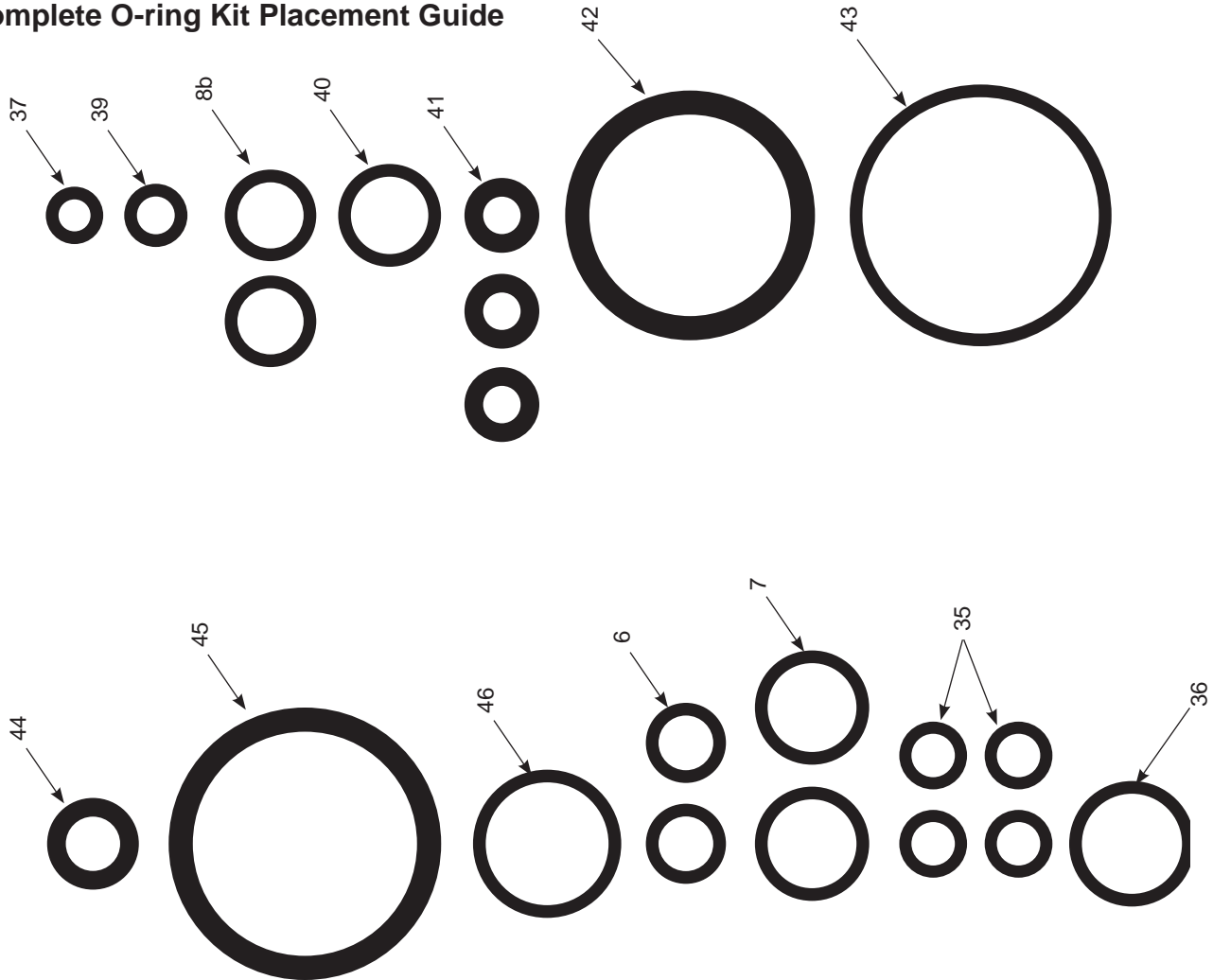

Section 3 - General Information: Options

Round Mixing Chamber	Mixing Chamber Nozzle Cleaning Drill		Mixing Chamber Hole Cleaning Drill	
GC250A	248891	.033	276984	.022
GC2500	GC0083	.049	GC0080	.035
GC2501	249112	.057	246629	.042
GC2502	GC0069	.071	246628	.052
GC2503	246625	.086	246627	.059
GC2504	246624	.094	296297	.067
GC2505	246623	0.116	246625	.086

DRILL PIN VISE 117661

Short Version				
Part No.	FAN Code	Spray Width in. (mm)	Orifice Diameter	
GC2573	215	2-4 (50.8 - 101.6)	0.015 in.	
GC2575	217		0.017 in.	
GC2578	221		0.021 in.	
GC2582	223		0.023 in.	
GC2589	231		0.031 in.	
GC2592	235		0.035 in.	
GC2623	411	8-10 (203.2 - 254)	0.011 in.	
GC2624	413		0.013 in.	
GC2574	415		0.015 in.	
GC2576	417		0.017 in.	
GC2625	419		0.019 in.	
GC2579	421		0.021 in.	
GC2583	423		0.023 in.	
GC2626	425		0.025 in.	
GC2586	427		0.027 in.	
GC2590	431		0.031 in.	
GC2593	435		0.035 in.	
GC2595	439		0.039 in.	
GC2627	511		0.011 in.	
GC2628	513		0.013 in.	
GC2629	515		0.015 in.	
GC2577	517		0.017 in.	
GC2630	519		0.019 in.	
GC2580	521		10 - 12 (254 - 304.8)	0.021 in.
GC2584	523	0.023 in.		
GC2631	525	0.025 in.		
GC2587	527	0.027 in.		
GC2591	531	0.031 in.		
GC2594	535	0.035 in.		
GC2596	539	0.039 in.		
GC2632	611	0.011 in.		
GC2633	613	0.013 in.		
GC2634	615	0.015 in.		
GC2635	617	0.017 in.		
GC2636	619	0.019 in.		
GC2637	621	12-14 (304.8-355.6)	0.021 in.	
GC2638	623		0.023 in.	
GC2639	625		0.025 in.	
GC2640	627		0.027 in.	
GC2641	711		0.011 in.	
GC2642	713		0.013 in.	
GC2643	715		0.015 in.	
GC2644	717		0.017 in.	
GC2645	719		14-16 (355.6-406.4)	0.019 in.
GC2646	721			0.021 in.
GC2585	723			0.023 in.
GC2647	725			0.025 in.
GC2648	727	0.027 in.		

Long Version			
Part No.	FAN Code	Spray Width in. (mm)	Orifice Diameter
GC2599	351	6-8 (152.4-203.2)	0.051 in.
GC2600	451	8-10 (203.2 - 254)	0.051 in.
GC2604	461		0.061 in.
GC2607	471		0.071 in.
GC2597	543		0.043 in.
GC2601	551	10 - 12 (254 - 304.8)	0.051 in.
GC2605	561		0.061 in.
GC2608	571		0.071 in.
GC2606	661	12-14 (304.8-355.6)	0.061 in.
GC2602	751	14-16 (355.6-406.4)	0.051 in.

Spacer Seals

Use only Brown series C spacer seals with series B spray-tips, failure to do so may result in material clogging.

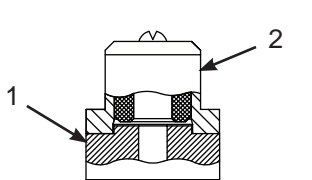
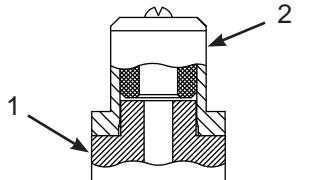
Series C Spacer Seals (Brown)	
Short Version	Long Version
Use with tips LPA2-147-1525 through LPA2-147-3850	Use with tips LPA2-147-4325 through LPA2-147-7250
GC2335	16V976
23564-00	16V972
23572-00	16V973
LPA2-121G	16V974
LPA2-124S	16V975
	
1 : Tip Spacer Seal (Series C) 2: Spray-tip (Series B)	

Section 3 - General Information: Options

P2 Spray Options

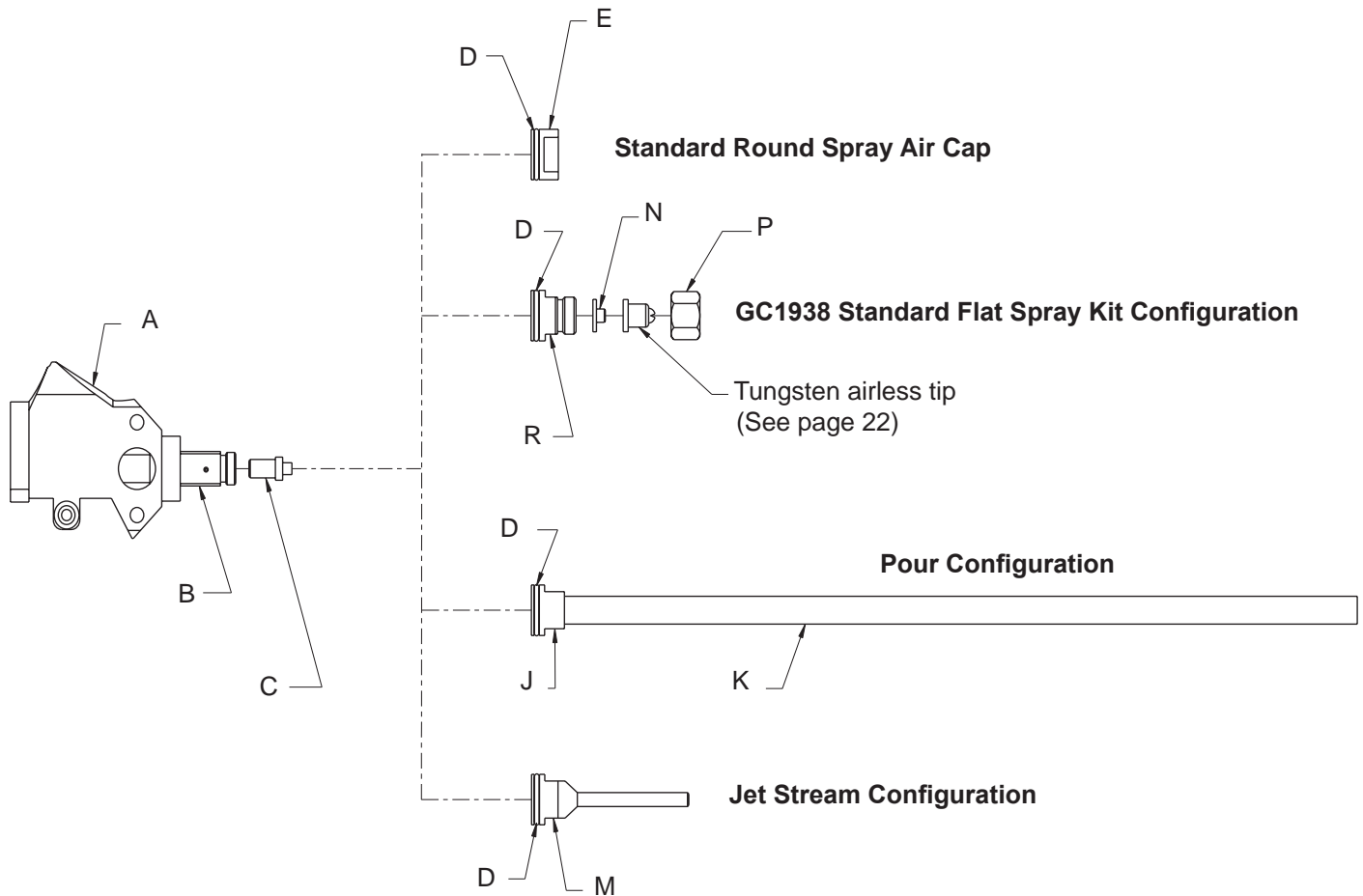

P2 Spray Options		
Ref.	Part	Description
A	GC1916	Gun Head
B	GC250X	Mix Chamber Body
C	GC251X	Mix Chamber Insert
D	117517	O-ring
E	GC1914	Front Tip
J	GC1954	Pour Cap
K *		Tubing, 1/4 in. ID
M	GC1952 GC1953	Jet Nozzle
N	GC2335 16V976	Seal
P	GC0257	Retaining Nut
R	GC1926	Flat Spray Adapter

* Purchase locally.

Section 3 - General Information: Options

Static Mixer Kit GC1956

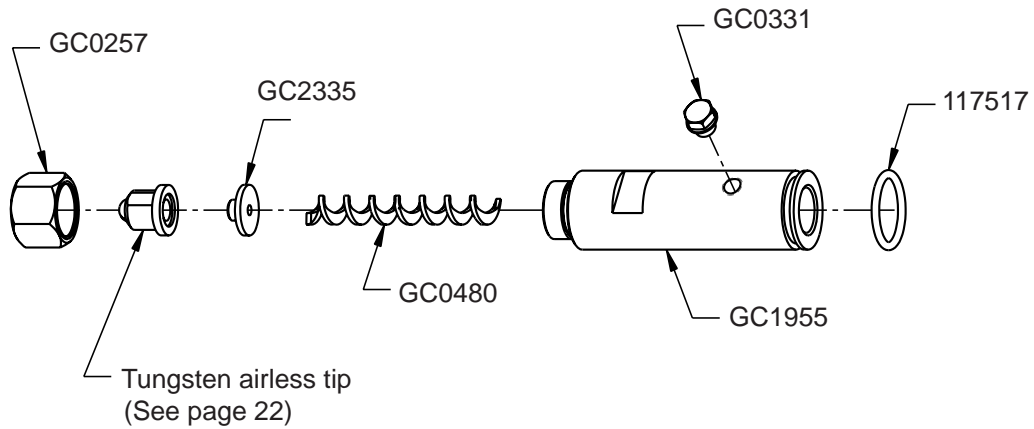

GC1956, Static Mixer Kit		
Part Number	Description	Qty.
GC2335 16V976	Fluid Nozzle Seal	1
GC0257	Nozzle Nut	1
GC0331	Plug Fitting	1
GC0480	Spiral Mixing Element	1
117517	O-Ring	1
GC1955	Static Mixer Adapter	1

Graco Standard Warranty

Graco warrants all equipment referenced in this document which is manufactured by Graco and bearing its name to be free from defects in material and workmanship on the date of sale to the original purchaser for use. With the exception of any special, extended, or limited warranty published by Graco, Graco will, for a period of twelve months from the date of sale, repair or replace any part of the equipment determined by Graco to be defective. This warranty applies only when the equipment is installed, operated and maintained in accordance with Graco's written recommendations.

This warranty does not cover, and Graco shall not be liable for general wear and tear, or any malfunction, damage or wear caused by faulty installation, misapplication, abrasion, corrosion, inadequate or improper maintenance, negligence, accident, tampering, or substitution of non-Graco component parts. Nor shall Graco be liable for malfunction, damage or wear caused by the incompatibility of Graco equipment with structures, accessories, equipment or materials not supplied by Graco, or the improper design, manufacture, installation, operation or maintenance of structures, accessories, equipment or materials not supplied by Graco.

This warranty is conditioned upon the prepaid return of the equipment claimed to be defective to an authorized Graco distributor for verification of the claimed defect. If the claimed defect is verified, Graco will repair or replace free of charge any defective parts. The equipment will be returned to the original purchaser transportation prepaid. If inspection of the equipment does not disclose any defect in material or workmanship, repairs will be made at a reasonable charge, which charges may include the costs of parts, labor, and transportation.

THIS WARRANTY IS EXCLUSIVE, AND IS IN LIEU OF ANY OTHER WARRANTIES, EXPRESS OR IMPLIED, INCLUDING BUT NOT LIMITED TO WARRANTY OF MERCHANTABILITY OR WARRANTY OF FITNESS FOR A PARTICULAR PURPOSE.

Graco's sole obligation and buyer's sole remedy for any breach of warranty shall be as set forth above. The buyer agrees that no other remedy (including, but not limited to, incidental or consequential damages for lost profits, lost sales, injury to person or property, or any other incidental or consequential loss) shall be available. Any action for breach of warranty must be brought within two (2) years of the date of sale.

GRACO MAKES NO WARRANTY, AND DISCLAIMS ALL IMPLIED WARRANTIES OF MERCHANTABILITY AND FITNESS FOR A PARTICULAR PURPOSE, IN CONNECTION WITH ACCESSORIES, EQUIPMENT, MATERIALS OR COMPONENTS SOLD BUT NOT MANUFACTURED BY GRACO. These items sold, but not manufactured by Graco (such as electric motors, switches, hose, etc.), are subject to the warranty, if any, of their manufacturer. Graco will provide purchaser with reasonable assistance in making any claim for breach of these warranties.

In no event will Graco be liable for indirect, incidental, special or consequential damages resulting from Graco supplying equipment hereunder, or the furnishing, performance, or use of any products or other goods sold hereto, whether due to a breach of contract, breach of warranty, the negligence of Graco, or otherwise.

FOR GRACO CANADA CUSTOMERS

The Parties acknowledge that they have required that the present document, as well as all documents, notices and legal proceedings entered into, given or instituted pursuant hereto or relating directly or indirectly hereto, be drawn up in English. Les parties reconnaissent avoir convenu que la rédaction du présente document sera en Anglais, ainsi que tous documents, avis et procédures judiciaires exécutés, donnés ou intentés, à la suite de ou en rapport, directement ou indirectement, avec les procédures concernées.

Graco Information

For the latest information about Graco products, visit www.graco.com.

For patent information, see www.graco.com/patents.

TO PLACE AN ORDER, contact your Graco distributor or call to identify the nearest distributor.
Phone: 612-623-6921 or Toll Free: 1-800-328-0211 Fax: 612-378-3505

Technical Assistance

Thank You for selecting GlasCraft spray equipment

Should you have any questions or need technical assistance, contact your factory authorized GlasCraft distributor.

Distributor: _____

Phone: _____

Contact: _____

For any issues your distributor cannot address, the GlasCraft technical service department is always available to assist you with the operation of your spray equipment. To help our technical representatives expedite your call and better address your questions, please have the following information ready and available when you phone GlasCraft.

*** If your questions are not urgent, You can e-mail all correspondence to service@glascraft.com**

Model: _____

Serial number: _____

Type of spray gun: _____

Serial number: _____

Is your equipment:

Single phase: _____ Three phase _____

What is the inbound voltage
to your equipment: _____

Temperature setting ISO: _____

Temperature setting POLY: _____

Temperature setting HOSE: _____

For Air Powered Systems:

Air compressor size: _____

CFM generated: _____

Pressure at the system:

Hydraulic _____ Pneumatic _____

Dynamic fluid pressure:

ISO _____ POLY _____

Spray gun chamber size: _____

Material being sprayed: _____

Viscosity: ISO _____ POLY _____

Approximate material temperature: _____

For Your Reference



Date Purchased _____
Distributor _____

Contact _____
Phone _____
E-mail _____

GlasCraft manufactures a complete line of polyurethane foam and polyurea coating spray systems. If your application is in-plant or a field contractor - GlasCraft has a system package to meet your requirements.

GUARDIAN - AIR POWERED / A5 & A6 SERIES EQUIPMENT

- . 6000 OR 12000 WATTS OF HEAT
- . 1600, 2200, OR 3000 PRESSURE SET-UPS AVAILABLE

MH, MH II, & MH III HYDRAULIC POWERED SYSTEMS

- . UP TO 45 LBS / MINUTE OUTPUT
- . EXCELLENT PERFORMANCE AND RELIABILITY

GUARDIAN MMH - MOBILE MODULAR HYDRAULIC SYSTEMS

- . SPECIFICALLY DESIGNED FOR ANY TYPE OF SPRAY RIG
- . GIVE COMPLETE UTILIZATION OF FLOOR SPACE IN MOBILE RIG

PROBLER P2 SPRAY GUN

- . IMPINGEMENT MIX / AIR PURGE
- . OPTIONAL NOZZLE FOR SPRAYING STUD WALLS, POURING & STREAM JET

For more information concerning any of these GlasCraft products,
contact your local authorized Graco distributor or visit www.graco.com

Notes

Quality and Performance...

GENUINE GLASCRAFT

Glas **Craft**

DISPENSING EXCELLENCE



www.glascraft.com

313213V

EN

Original instructions.

This manual contains English.

Revised June 2014

A GRACO COMPANY

GRACO INC. AND SUBSIDIARIES
P.O. BOX 1441
MINNEAPOLIS MN 55440-1441
USA

Phone 612-623-6921

Toll Free 1-800-328-0211

Fax 612-378-3505